

通信ポート

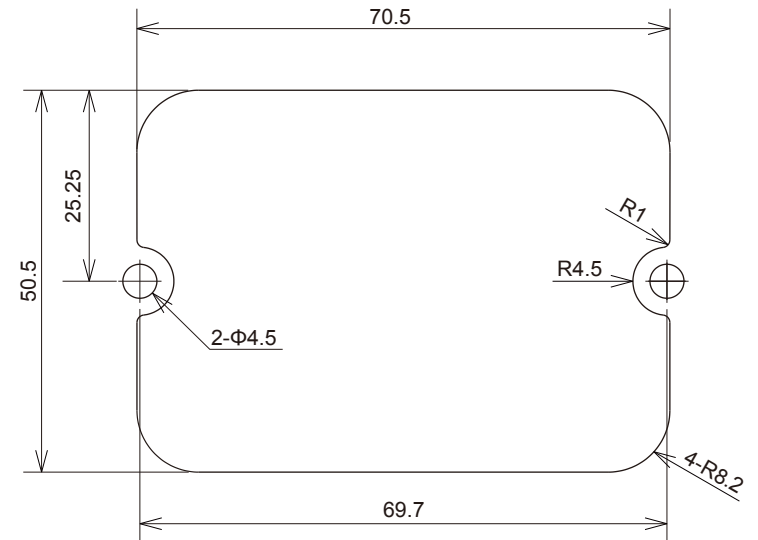

正面パネル取付穴

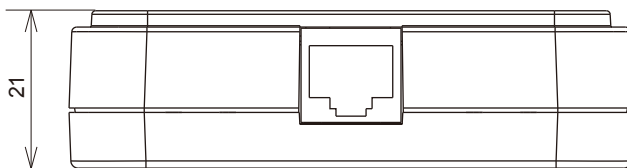
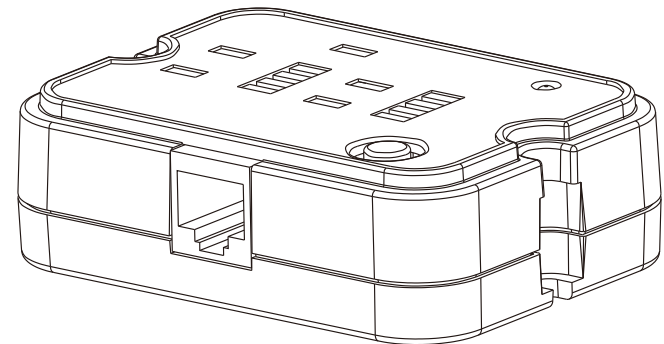

UNIT (単位) : mm



SCALE (尺度) 1:1	NAME (名称) リモートコントローラ
TOLERANCE (公差)	
DATE (作成日) 2016.6.3	TYPE (型式) IRC3
株式会社電菱	DWG.NO. (図番) DI-D-031