

電菱  
'16.11.16  
開発課

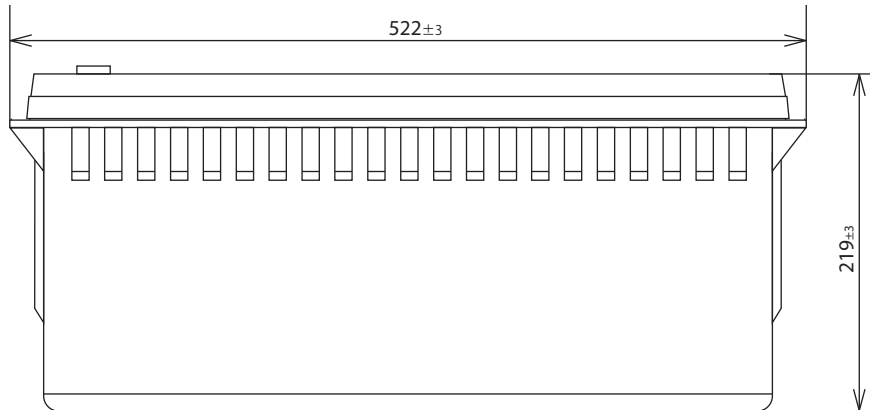
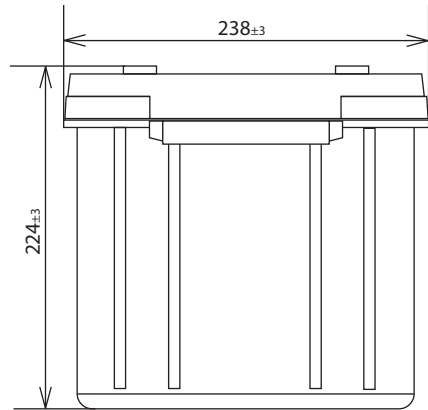
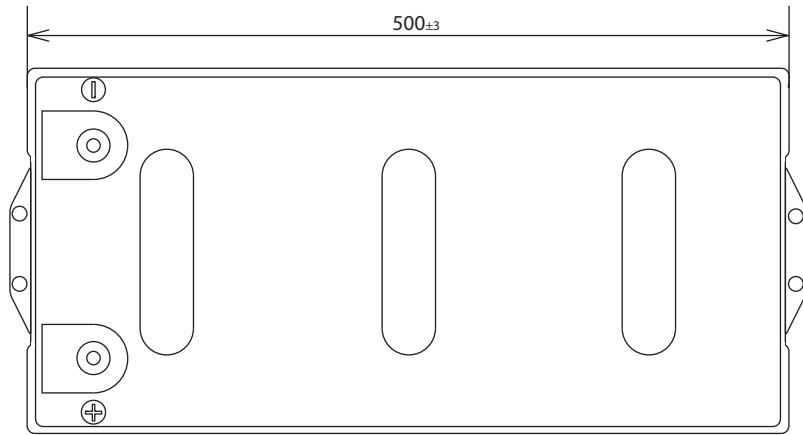

SCALE (尺度) 1:5	NAME (名称) 密閉型サイクルバッテリー
TOLERANCE (公差) REFER TO TOLERANCE LIST	
DATE (作成日) 2016.10.21	TYPE (型式) JR230-12
株式会社 電菱	DWG.NO. (図番) DB-L-010